

S

581

H8

YC 65649

UC-NRLF



\$B 75 276

PRACTICAL FARM BUILDINGS

UNIV. OF CAL.
EXPT. STA. LIB.

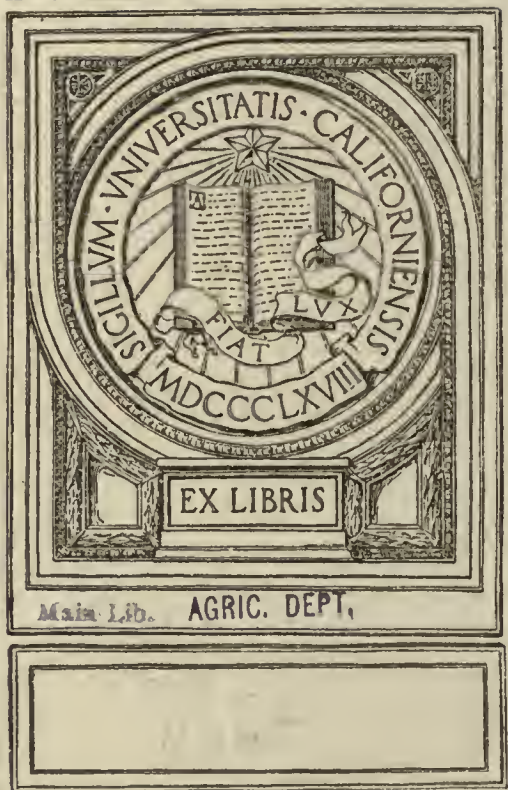

EX LIBRIS

Main Lib. AGRIC. DEPT.



Digitized by the Internet Archive
in 2007 with funding from
Microsoft Corporation

<http://www.archive.org/details/practicalfarmbui00huntrich>

PRACTICAL FARM BUILDINGS



Practical Farm Buildings

Plans and Suggestions *By A. F. Hunter*



PUBLISHED BY

F. W. BIRD & SON

Established 1817

EAST WALPOLE, MASS., U. S. A.

NEW YORK

WASHINGTON

CHICAGO

Canadian Factory and Office, Hamilton, Ont.

COPYRIGHT, 1905, F. W. BIRD & SON

PRACTICAL FARM BUILDINGS

1. POULTRY HOUSES.

5581
H8

Bulletin No. 16 of the *Cornell Reading Course for Farmers* is entitled "Building Poultry Houses," and from it, and Farmers' Bulletin No. 141 of the U. S. Department of Agriculture, many of the hints and suggestions here used are borrowed; a few of the poultry house plans are adapted from recent poultry periodicals; for their courtesy our thanks are hereby tendered. Farmers' Bulletin No. 141, says: "Poultry houses need not be elaborate in their fittings or expensive in construction. There are certain conditions, however, which should be insisted upon in all cases. In the first place, the house should be located upon soil which is well drained and dry. A gravelly knoll is best, but, failing this, the site should be raised by the use of the plow and scraper until there is a gentle slope in all directions sufficient to prevent any standing water even at the wettest times. A few inches of sand or gravel on the surface will be very useful in preventing the formation of mud. If the house is sheltered from the north and northwest winds by a group of evergreens, this will be a decided advantage in the colder parts of the country."

In *Building Poultry Houses* Professor Rice puts "suitable buildings, properly located" as the first of the four cornerstones upon which success rests, and in giving the buildings this prominence we believe he is entirely right; no one thing does more to promote or hinder successful work with poultry than the buildings, and to aid the reader to a wise decision as to which of many different patterns of poultry houses is best adapted to his purposes we offer these plans and suggestions.

Select a *dry location*; if the ground is not naturally dry, make it so by draining it. The first illustration gives a plan for making the interior of a poultry house absolutely dry if the ground is well drained. The foundation walls are built up eighteen inches above the ground level. Ten or twelve inches of this space is filled in with small stones or coarse gravel, and the balance with fine sand or dry, sandy loam; outside the ground is sloped up to the level of the bottom of the sills, and all the surface water is effectually turned away.

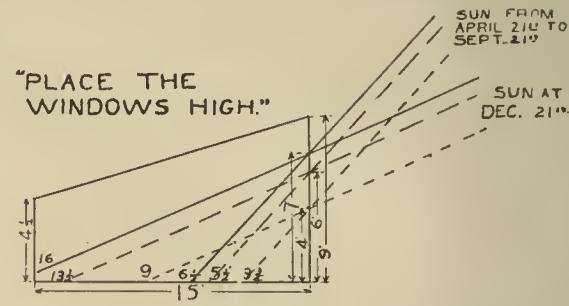

FIG. 2.

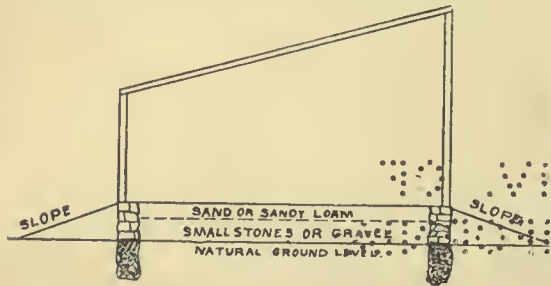

FIG. 1—A plan to secure dryness.

Dampness is fatal to hens; drain to promote dryness. It is better by far to have a cold, dry house than a warm, damp house. The warmer the air the more moisture it will hold. When this moist air comes in contact with a cold surface, condensation takes place which is often converted into hoar frost. The remedy, therefore, is to remove the moisture, as far as possible, by first cutting off the water from below which comes up from the soil. The water table is the same under a hen-house as it is outdoors. Dirt floors are therefore damp. Stone filling covered with soil is hard to clean and only partially keeps out dampness. Board floors are short lived if the air is not allowed to circulate under the house. If the foundation walls are not tight, the floors are cold. In any case they harbor rats. A good cement floor is nearly as cheap as a good matched-board floor, counting lumber, sleepers, nails, time, etc. When once properly made it is good for all time. It is practically rat-proof, easily cleaned and perfectly dry, cutting off absolutely all the water from below. If covered with a little soil, or straw or both, as all kinds of floors should be, it will be a warm floor.

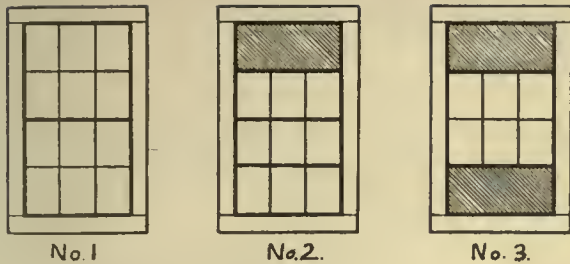

FIG. 3—An experiment with curtains in windows.

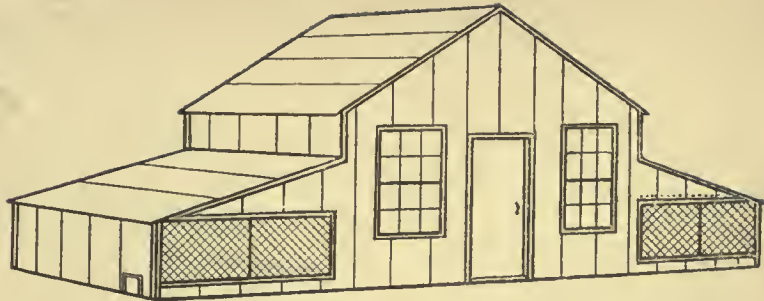

FIG. 4—An implement house adapted for poultry.

Other things that can be done to keep dampness out of the air is to use absorbents, like dry dust, land plaster, or South Carolina rock on the droppings, which should be frequently removed; and by keeping plenty of dry straw, swale hay, buckwheat hulls, etc., on the floor overhead and used for scratching litter on the floor of the pen.

Secure shelter where possible by building in the lee of a windbreak or a hill, or of other farm buildings. Buildings that face the south will get the largest amount of exposure to the sun's rays; other things being equal, they will be warmer, drier, and more cheerful. Too much glass makes a house too cold at night and too warm during the daytime, because glass gives off heat at night as readily as it collects it in the daytime. Much glass makes construction expensive. Allow one square foot of glass surface to about 16 square feet of floor space, if the windows are properly placed. The windows should be high and placed up and down rather than horizontally and low. In the former the sunlight passes over the entire floor during the day, from east to west, drying and purifying practically the whole interior. (See Fig. 2.) The time when sunshine is most needed is when the sun is lowest, from September 21 to March 21; the arrows show the extreme points which the sunshine reaches during this period.

Much of the dampness in poultry houses in winter is due to the condensation of the moisture of the breath of the fowls. The warm air exhaled from the lungs is heavily charged with moisture. In recent years considerable success has attended efforts to eliminate this moisture by ventilating the pens through cloth curtains set into the tops of the doors (see plans of Dr. Bricault's poultry house, page 8, and the Maine Experiment Station house, page 9) or set into part of the window space. In Fig. 3 is shown an illustration of an experiment tried on the Lone Oak Poultry Farm, Reading, Mass., last winter. Being much annoyed by the moisture which collected on the roof and walls in the night, and, melting, dropped to the floor when the sun warmed the roof and walls during the day, frames the size of one fourth of each window were made and common muslin tacked on. To better ascertain the effect of the curtains the windows in house No. 1 were left closed, as formerly; in house No. 2 the top sash was dropped the length of one light and a curtain set in the place; in house No. 3 the windows were dropped from the top and raised from the bottom, curtains being set in the spaces. In house No. 1 the dampness and "chill" remained as before; in house No. 2 there was some improvement; in house No. 3 there was a great improvement; and the temperature, in the coldest days of the winter, was about six

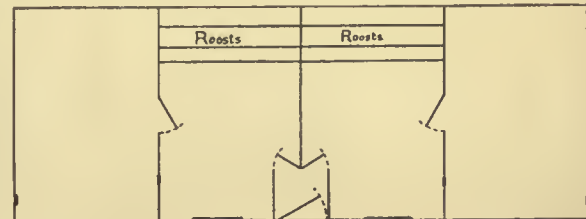

FIG. 5—Ground plan.

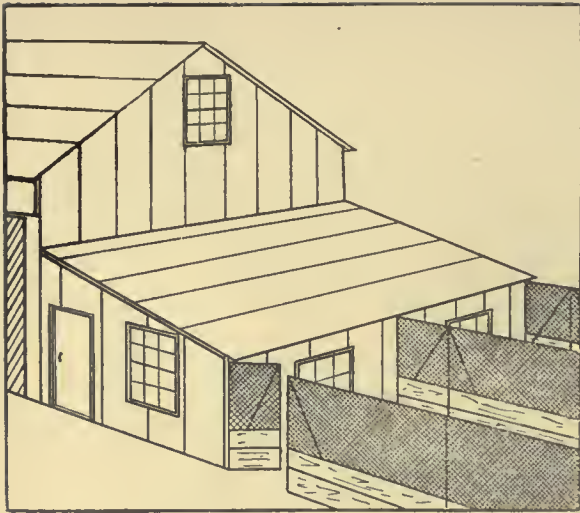

FIG. 6 A lean-to poultry house.

one or two open-front scratching sheds for exercise and fresh air. (Fig. 4 and 7.) In case there is no building suitable for remodeling into a poultry house, an inexpensive lean-to may be built on to the south end of the stable. (Fig. 6.) A house of this kind can be simply, economically, and conveniently built, and well supplies the conditions for successful poultry keeping.

Sometimes a dweller in the suburbs wants to keep a small flock of poultry, to supply the family with fresh eggs through the fall, winter, and spring and then fresh meat for the table; well-matured pullets being bought new when fall comes again. For such purpose the plan given in Fig. 8 is well adapted, and it can be built of a size to suit convenience; eight feet long by five feet deep, six feet high in front, and four feet six inches at the back, makes a usable small house, which can be easily moved to another location if desired.

Excellent patterns of small poultry houses, well adapted to the suburban lot, are shown on pages 6 and 11; these "Colony" houses have proved their merits in many different localities. They are especially valuable on a farm, where it is desirable to locate a flock of half-grown chickens out in a grain field; or on a poultry farm where extra room is needed for surplus stock and cockerels which are to be sold for breeding purposes. A solid board floor enables shutting the birds in at night and keeping them in till the team has drawn them to the new location in the morning; it also secures the birds against marauding animals at night, if the slide door has been closed.

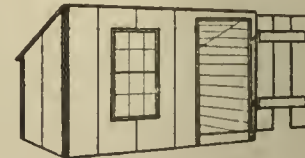

FIG. 8 A small portable poultry house.

degrees warmer in house No. 3 than in No. 1, where the windows were all closed tight. The two curtains were not quite sufficient to dry out the moisture, which had already got well established, but it is believed that having the curtains to put in the windows, both top and bottom, as soon as freezing weather comes in the fall, they will be able to keep the houses well ventilated and quite dry.

The shape of the roof of the poultry house influences the cost, and we give the preference to plans of houses with single-span roofs. These houses are easiest and cheapest to build, and with the slope of the roof to the north we get the much desired vertical front, with room for the windows to be placed high to secure sunshine, and with all the drip of the roof carried off to the north, the ground in front of the house is dry. It also is cooler in summer, as it is not exposed to the direct rays of the sun.

Not infrequently there are small buildings on the place which can be easily and economically adapted to poultry use; as, for example, an old implement house, or tool shed, which can be made into a one or two pen house, as desired, by arranging windows and doors and adding

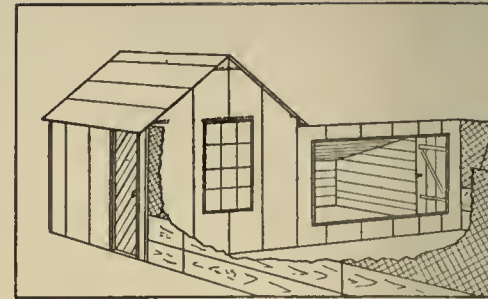

FIG. 7 Implement house with scratching shed added.

In Fig. 9 we give an illustration of an elevated poultry house used in Florida, which was published in the *Poultry Standard*, of Stamford, Conn., and described as made of Neponset Red Rope Roofing, both top and sides; a better construction would be Paroid Roofing for roof and sides, or Paroid for roof, and Neponset Red Rope Roofing for the ends and sides. This house is built upon posts set in the ground and extending to the roof, five feet above the ground at the back and six feet high in front; the six posts, three front and three back, are all the frame required. The light furring to sustain the roof and sides is nailed to the posts, and the Roofing securely nailed to the strips of furring.

The open space below the house is enclosed by one inch mesh wire netting; there is no floor, and a narrow platform along the rear, inside, gives the hens access to the nest boxes, which are hinged at one end and swing out as shown in the drawing. The roost poles should be a foot above the open bottom, to be quite sheltered from winds.

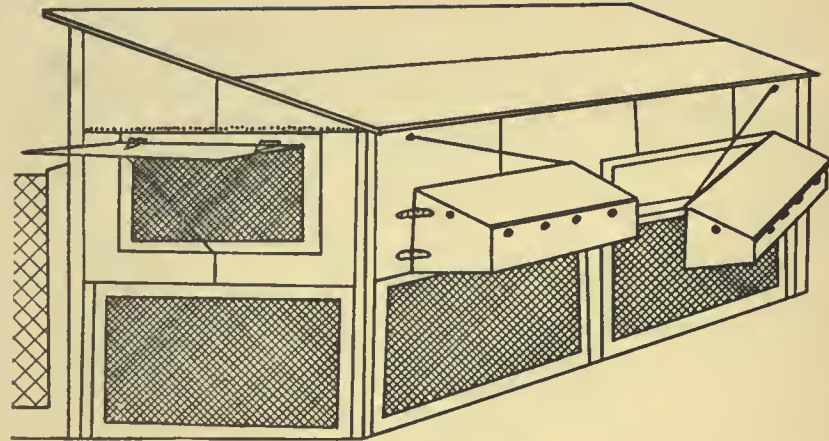

FIG. 9 A Florida poultry house.

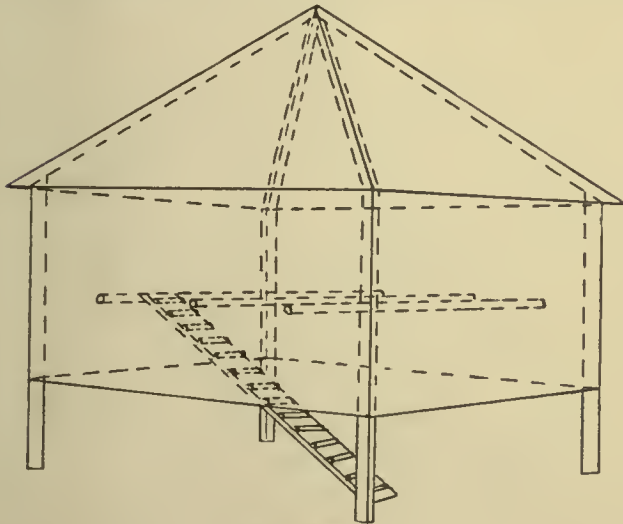

FIG. 10 A California "Mushroom" poultry house.

Of similar pattern is the "Mushroom" poultry house, from Southern California. These houses may be built any size, but are usually made four or five feet square. The posts are four and one half feet high and the sides left open for a distance of eighteen inches at the bottom. There is no floor used, the air circulating freely beneath. When built of boards no frame is needed, the boarding being nailed to the posts. The roof goes up from all four sides, in pyramid form, and is made water tight. The roosts are placed about fifteen or eighteen inches above the bottom, as shown by the dotted lines, and a walk or ladder is provided which leads from the ground to the rear roosts. This is made movable, so that it can be taken down at night, thus protecting the fowls from marauding animals.

Some of the houses are built of iron advertising signs, and have the common double-pitch roof; in some cases the sides are made of burlap tacked on to furring, which is nailed to the posts. This burlap is then painted with crude oil, distillate and Venetian Red to make it wind proof. Lumber is very expensive in that section, and the burlap, when water-proofed, makes a cheap and quite desirable house.

A better water tight and economical construction would be Paroid Roofing for the roof and Neponset Red Rope Roofing for the sides.

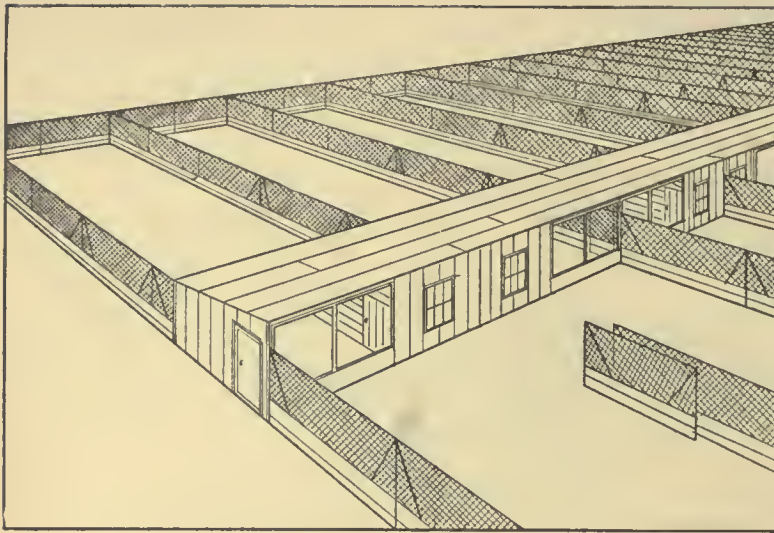

FIG. 11—Continuous scratching-shed poultry house, with double yards.

the house itself and a gate opening out of the scratching shed; for ordinary visits to the north yards there are small, swinging gates next to the house, and then lift-gates which will admit a team for plowing, etc.

Small, detached houses for individual flocks of fowls are becoming more and more popular amongst poultrymen, and one of the leading poultry periodicals is authority for the statement that the one-time popularity of the long poultry house is distinctly waning. The "Colony" house, as it is called, possesses many advantages which cannot be found in the long house, and it is but truth to state that it has much adaptability to a variety of uses. Among these are housing a flock of fowls in winter, and it is then sometimes convenient to draw them up together, so as to save steps in going from one to another; using them as brooder houses in the spring; colonizing flocks of youngsters in them out in the grass fields directly after the hay crop is harvested; housing surplus males in them in the fall, etc.

An excellent plan of colony house is given in Figs. 12 and 13, and comes from the Connecticut Experiment Station; this combines the advantages of the scratching shed with a colony house. This house is sixteen feet long by six feet wide, is six feet high in front, and four feet high at the rear, the roosting apartment being seven by six feet and the scratching shed nine by six feet in size.

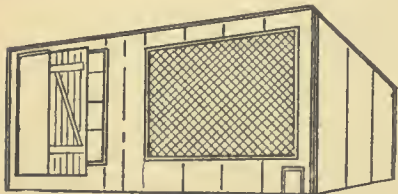

FIG. 12—Colony poultry house at Connecticut Experiment Station.

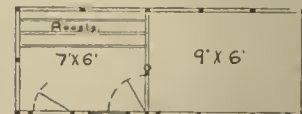

FIG. 13—Ground plan.

THE SCRATCHING-SHED POULTRY HOUSE.

A continuous house, with alternating curtained-front scratching sheds and closed roosting pens, has been growing very rapidly in popular favor with practical poultrymen, and probably combines more advantages with fewer disadvantages than any other one style of poultry house. Each combined pen and shed is eighteen by ten feet, the curtained-front shed being ten by ten, and the roosting pen eight by ten feet—room sufficient for twenty-five to thirty head of fowls of the American varieties, or thirty-five to forty Leghorns. No alley is required in this plan of house, the walk being through the pens and sheds, as shown in the ground-plan.

We would build this house seven feet high in front and five feet high at the back. Sills and plates are all of two by four scantling, halved and nailed together at joints. The rafters, corner studs, and studs in centers of fronts of sheds are all two by four; the intermediate studs are two by three. Set the sills on stone foundation a foot and a half above the ground level, or on posts set into the ground below the usual frost line, the posts being set five feet apart excepting in front of roosting pens (where they come four feet apart),—there being a post at corner of each pen and shed, with one between. The rafters should be two feet between centers; as lumber comes twelve, fourteen, or sixteen feet in length, and two-feet-apart rafters allow the lumber to be used with almost no waste. The sills we would set a foot and a half above average ground level. When set on posts put hemlock (or some hard wood) boards from bottom half of sill down to ground, nailing them firmly to sill and foundation posts; then fill up inside to bottom of sills and slope the ground outside to same height, as illustrated in Fig. 1. Toe-nail studs to sills firmly, plates to studs ditto, and rafters to plates. Set the studs in front of roosting pens to take the window frames (or the window sash, if no frames are used), and in partitions a stud should be set to take the two and one half feet wide doors and gates. All of the framing is simple and easy, and any man who can saw off a board or joist reasonably square and drive nails straight can build this house; the slight level at each end of rafters being perfectly simple. All boarding is lengthwise, the boards being firmly nailed and good joints made all over. Cover the roof and sides with Paroid, and the house will be wind and water proof. A twelve-light window of eight by ten glass is set in the front of each roosting pen, and all doors and gates are two and one half feet wide by six feet high. If you cannot afford Paroid for both roof and sides, we recommend it for roof and Neponset for sides.

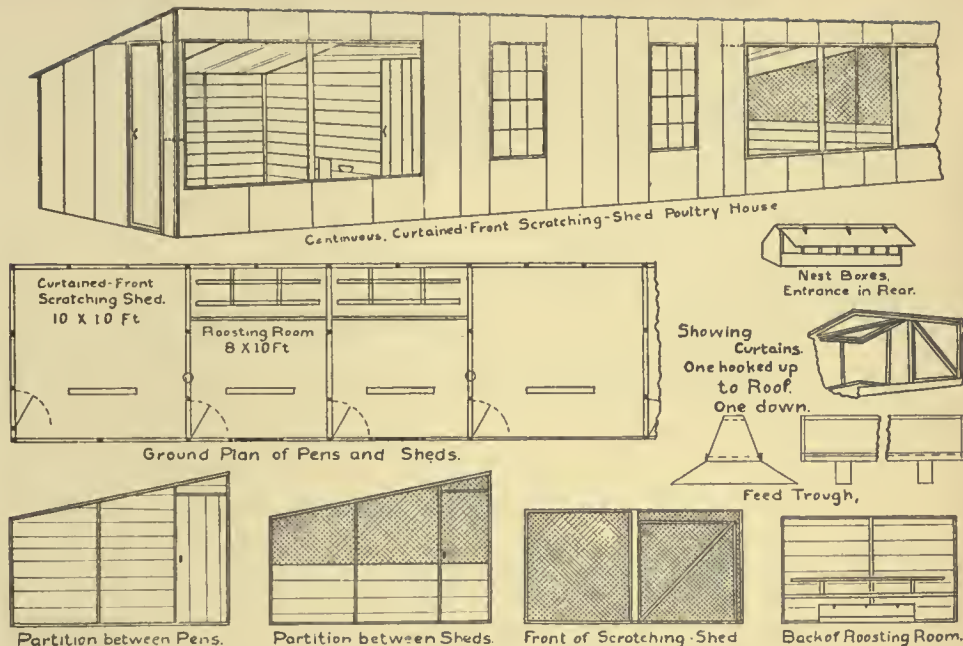

FIG. 14—Continuous curtained-front, scratching-shed poultry house.

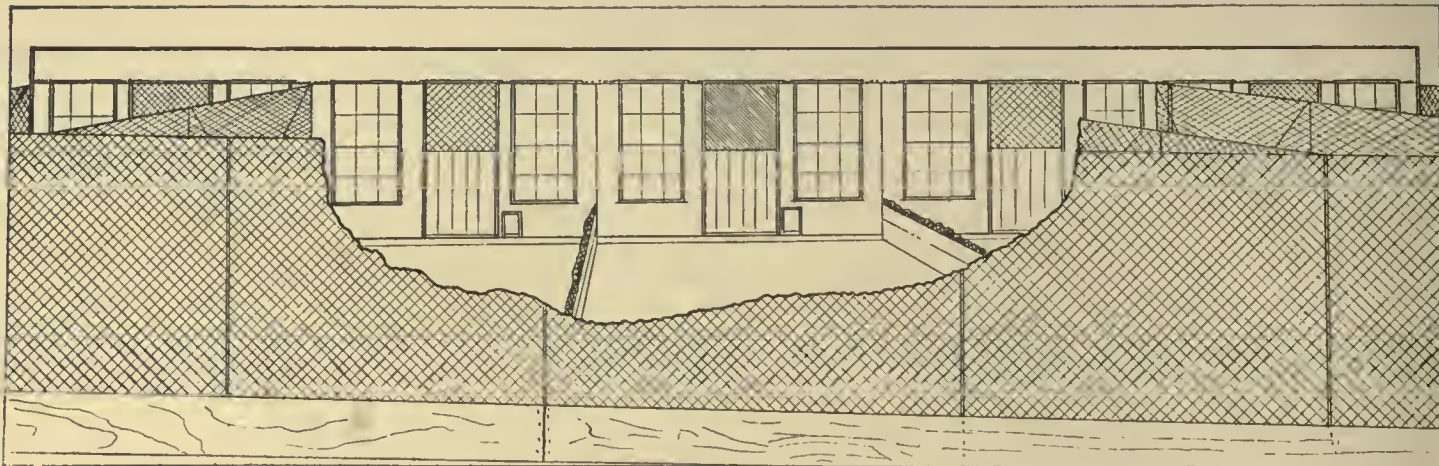

FIG. 15 Dr. Bricault's "New Idea" poultry house.

DR. BRICAULT'S "NEW IDEA" POULTRY HOUSE.

Desiring a poultry house which would give closed pens or could be opened up to admit the air and sunshine at will, Dr. C. Bricault, Andover, Mass., adapted the well-known "Dutch door" to his purpose, putting the door in the middle of the front of each pen, and so arranging it that the whole door could be open day and night, in warm weather, or the lower half of the door shut and the top half open, or the top half could be closed by a curtain in quite cold weather, and in severe storms the whole door closed. The size of the pens is ten by twelve feet, the frame and building plan being substantially the same as in the preceding house-plan, the doors in the front of each partition giving a passage through the entire length of the house. There are two windows in the front of each

pen; the roosts are set against the partitions between the pens, and the trap-nests are set on a platform against the north wall. The building is covered with a cheap sheathing paper, then with sheathing quilt, then Neponset Red Rope Roofing; a better construction would be Paroid Roofing on the roof and Neponset on sides.

Fig. 16 shows a front perspective of the house, with the lift-off gates taken down to permit driving through the yards; Fig. 17 gives an interior view of one of the pens, showing roosts and trap-nests.



FIG. 16 Front elevation, showing gates opening through.

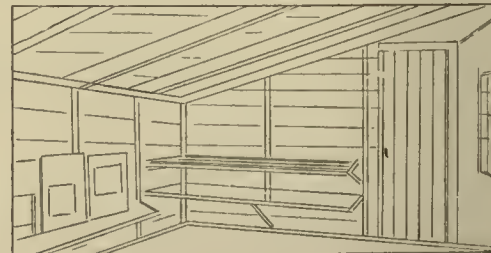

FIG. 17 Interior of pen.

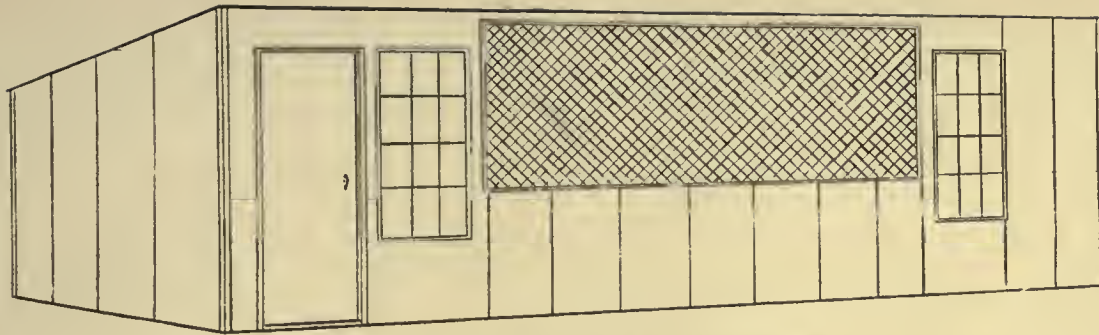

FIG. 18 Curtain-front poultry house at the Maine Experiment Station.

THE MAINE EXPERIMENT STATION CURTAIN-FRONT HOUSE

The most advanced poultry-house construction has been developed on the poultry plant of the Maine Experiment Station, and consists of a house-front half open, excepting that there is a cloth curtain in the opening (on cold nights and in stormy weather), and there is an elevated roosting closet with another cloth curtain in front. It seems almost cruelty to animals to put hens in houses where they have only two cloth curtains between them and the cold of winter in central Maine, but a bulletin recently published says: "These curtain-front houses have all proved eminently satisfactory. Not a case of cold or snuffles has developed from sleeping in the warm elevated closets with the cloth fronts, and then going down into the cold room, on to the dry straw, and spending the day in the open air. The egg yield per bird has been as good in these houses as in the warmed ones.

The Maine Station has now three of these curtain-front houses. Of the two long houses one is one hundred and fifty by twelve feet, divided into pens twenty by twelve feet, in each of which are housed fifty hens; the other is one hundred and twenty by sixteen feet, divided into pens thirty by sixteen feet, and one hundred hens are kept in each.

Fig. 18 gives a single pen of the one hundred and fifty foot long house, with a door opening into the pen from a board walk along the front. Each pen has two windows, which light the interior when it is necessary to keep the curtain down; the space at the east end is occupied by nest boxes. The curtain in front is twelve by four feet, is hinged at top so it may be swung up against the roof and hooked up there; the roosting closet is up three feet from the floor, the platform is three feet wide, and the curtain which closes the front is the whole length of the pen, is hinged at the top and swings up against the roof, where hooks secure it out of the way. The whole floor of the pens is open for exercise, and is an enclosed out-of-doors pen all the time.



FIG. 19—Nest boxes



FIG. 20—Rear of pen, showing roosting-closet.

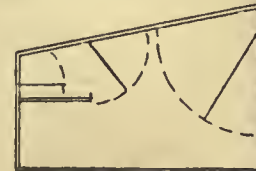

FIG. 21—Cross-section.



FIG. 22—A long poultry house on the White Leghorn poultry yards, Waterville, N. Y.

A POULTRY HOUSE 250 FEET LONG

In New York State it has been thought desirable to have warm houses for the Single Comb White Leghorns so largely kept there, and we give an illustration of one of the long poultry houses of the White Leghorn Poultry Yards, Waterville, N. Y. This house is two hundred and fifty feet long by sixteen feet wide, divided into pens twelve feet square and a walk three and a half feet wide along the north side. It has a floor of seven-eighths inch matched boards throughout. The outside walls are first boarded, then covered with sheathing paper and clapboarded. The inside of the building is boarded up with matched boards on the inside of the studs, making a four-inch dead air space between the walls. The ceilings are made of matched hoards laid at the level of the plates. In this ceiling, over the center of each pen, is a small trap door, two feet square, opening up into the attic space above, which is designed to give diffusive ventilation.

Three ventilating cupolas cap the roof and there are full-sized windows in each gable end. This attic space is a storage room for straw, which is drawn upon from time to time to furnish scratching material for the pen floors, and opening the trap door in the ceiling (Fig. 23) gives excellent ventilation without drafts. A door opens from the alleyway into each pen, and doors in the partitions between the pens permit passing through from pen to pen. The roost platforms with nest boxes beneath are against the partitions between the walk and pens (Fig. 24), and the plan of partitions between pens is shown in Fig. 23. The roof is covered with Paroid roofing. A fault here is the wire netting in these partitions, which invites drafts; a better plan would be matched board partitions throughout.

The twelve feet square pens have one hundred and forty-four square feet of floor space each, giving ample room for twenty-five head of layers, and while a long house of this description is somewhat expensive to build, it has many advantages, which, on a large and permanent poultry plant, will more than make up for the first cost in the ease and economy of feeding, etc., and the warmth of the house and simplicity of ventilation. This style of poultry house has been in use on the White Leghorn farm for several years, and has been found to be both practical and economical; it combines very completely the laying and breeding house. On this plant they practice the alternate system of males in the pens, a small coop for the extra male being set against the partition in one corner of the pen, four feet up from the floor. One male bird is cooped up while the other runs with the hens and they are exchanged every two or three days, the change being effected at night.

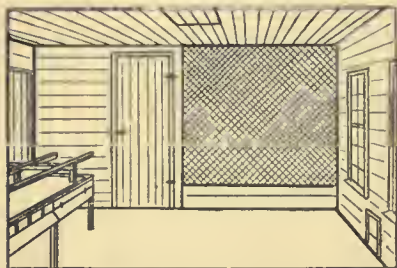

FIG. 23—Interior, showing partitions between pens.

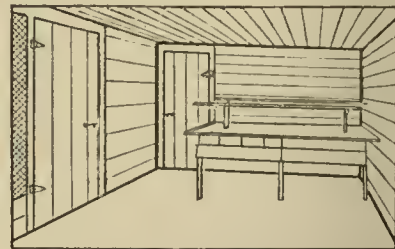

FIG. 24—Interior of pen, showing roosts.



FIG. 25—Mr. A. G. Duston's five-pen breeding house.

MR. DUSTON'S POULTRY HOUSES.

One of America's most successful poultrymen is Mr. Arthur G. Duston, of South Framingham, Mass., and as he has recently established himself on a new farm, to secure necessary room, the type of poultry houses he decides are the best for him is of interest. He is building seventeen houses of five pens each, and uses some thirty odd of his well-known colony houses (Fig. 27). The five-pen houses are raised from the ground from two to three feet, the space beneath being utilized as scratching room. Each house is fifty by twelve feet, the pens being ten by twelve feet each, and there are two windows in the front of each pen; doors in the front of partitions allow passing through from pen to pen. The roosts are at the back, with nest boxes beneath the roost platforms.

This house has a short hip-roof sloping south, which is open to the objection of carrying part of the roof-drip to the front of the house,—a fault which can be mitigated by a gutter along the front, but that increases the cost without always giving complete relief from the drip; we decidedly prefer the single slope roof.

Mr. Duston's "colony" or portable, houses are justly favorites, the distinctive feature of them being the double door, or wire netting door covered with a second door. The advantages of this door are great; they give excellent ventilation without drafts, and complete security from four-footed foes. These "colony" houses are ten by five feet on the ground, five feet high in front, and four feet high at the back, and have board floors.

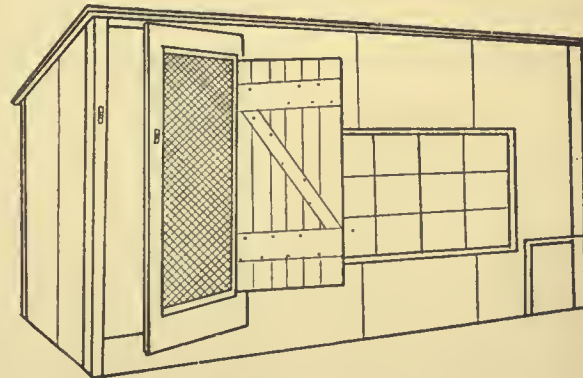

FIG. 27—Mr. Duston's "Colony" house.

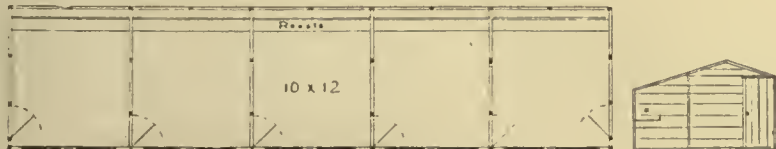

FIG. 26—Ground plan and cross section

2. BARN, STABLES, ETC.

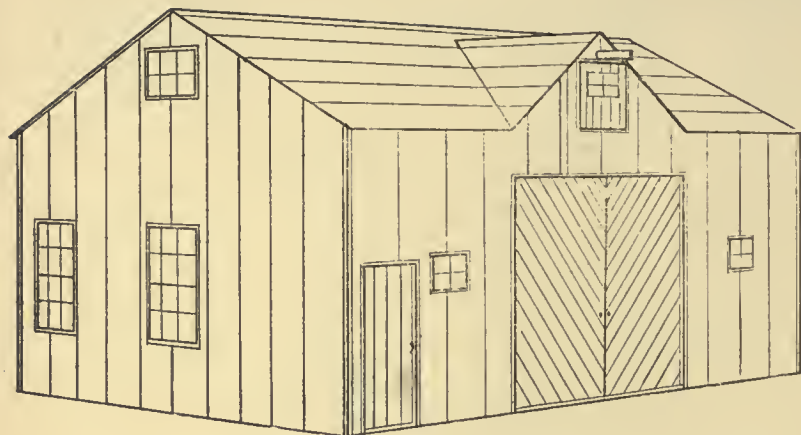

FIG. 28—A village stable for a horse and cow.

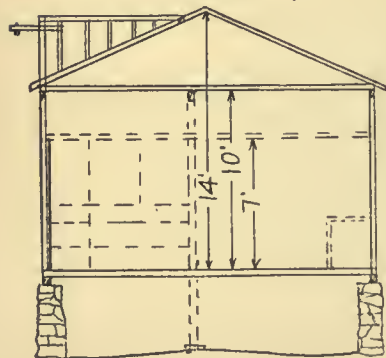

FIG. 29—Cross-section.

the floor extend across each end and may be joined at the rear if desired; a scaffold floor above the large doors extends from front to rear, or to the drop-scaffold walk connecting the two side scaffolds at the rear. A basement six or seven feet deep under the whole is a valuable addition to such a stable, making room for storing and rotting the manure, and a storage room for roots, etc., in one corner.

Six-inch-square sills, posts, and floor stringers are amply strong for the strain usually put upon a small stable, and the center posts, set at corners of box stall and cow stalls, help carry the main floor and the storage floor above. If preferred, the intermediate posts may be set in the center and the stall-spaces extended a foot, making them 8 x 9 feet. With the roof covered with Paroid roofing, and the sides with Neponset Red Rope Roofing battened on laps and halfway between laps, a very neat and economically constructed stable is made.

There is great diversity in plans of barns and stables, the taste of individual owners seeming to favor this or that plan, as they think it best adapted to their needs. We have thought it wise to give here a few simple, practical plans, which have approved themselves in actual use. Barns and stables need not be expensive in construction nor elaborate in fittings; the important considerations are the convenience of the owner and the adaptability of the building to its purpose.

In Figs. 28, 29 and 30 we give a plan for a village stable, for the man who keeps a horse and one or two cows, and the ground floor also provides room for the work-bench (which is most desirable where there are boys in the family), besides standing room for the carriage, wagon, and sleigh.

This stable is planned to be twenty-six feet long by eighteen feet wide, is ten feet from floor level to eaves, and fourteen feet from floor to ridge of roof. More pitch can be given to roof if desired, but with a good roofing like Paroid the roof slope may be slight. It would be better to make the walls two feet higher if more storage space is desired above the scaffold floor. The doorway is eight by eight feet, and stall space eight by eight feet is made in each front corner; a box stall is provided for the horse and two cow stalls in the left-hand corner, with a small door opening into the cow linter. Hay scaffolds seven feet above

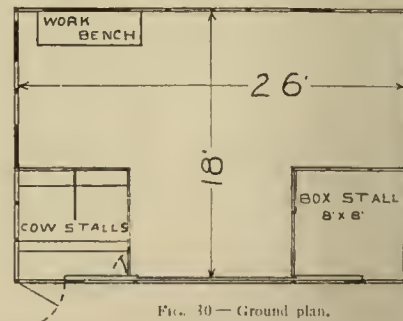

FIG. 30—Ground plan.

The farm barn is a most important aid to economy of labor, if rightly planned, and we give on this page the plans of a small barn, for a farm where eight or ten cows are kept, such as is quite common in New England and the Middle States, and which gives excellent satisfaction everywhere. On the farm where this plan was studied the pair of horses were housed in a small horse barn nearer the dwelling house, the Democrat wagon, canopy top carriage and sleigh, etc., being under the same roof.

This barn is forty-four feet long by thirty-four feet wide, and is built in four "bays" of eleven feet in length each. The main floor is twelve feet wide, and hay wagons drive in at either end and out at the other. The cow stalls occupy all of the linter on the south side, a door at the end opening into the lane to the pasture. The first bay on the north side is ceiled up with tongued and grooved boards, has a tight floor overhead, and is used as a grain storeroom; the other three bays on that side are hay mows from floor to roof.

Over the main floor and fifteen feet above it is a floor for hay, or corn, or used for general storage at different seasons. There was no floor on the collar-beams when the present owner bought the farm. Strong poles had been laid across the space and surplus hay thrown on them; since being floored over the

owner says it is the best part of the barn, and invaluable for drying out crops not fully cured. A basement about six feet in depth receives the manure from the cows, and three or four hogs have the run of the cellar and manure heaps, thoroughly rotting and "fining" the manure for the next season's crops.

The frame of this barn is of eight-inch square hemlock timber, the braces three by four inch hemlock mortised into posts and stringers, the floor stringers three by nine inches, two feet apart and well cross-bridged, the floor of three-inch plank. The scaffold floor is of inch boards laid on two by six inch stringers three feet apart, and is amply strong for any load put upon it.

Grain bins along two sides of the grain room may be four feet wide, and, fitted with drop fronts, may be five feet high and divided into two or more compartments. Two small bins may be fitted in each side of the window; the window may be in the end if preferred.

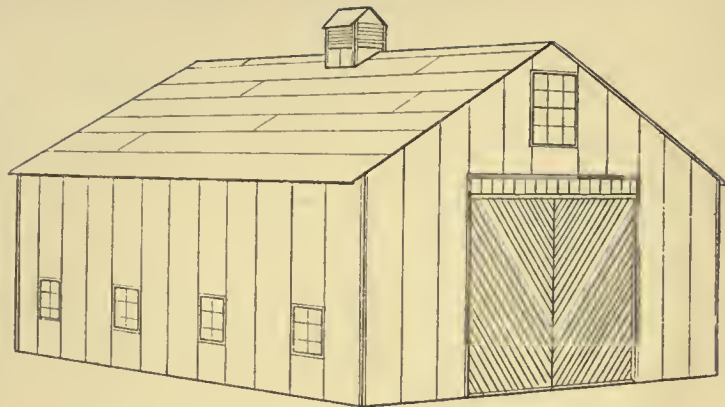

FIG. 31—A barn for a small dairy farm.

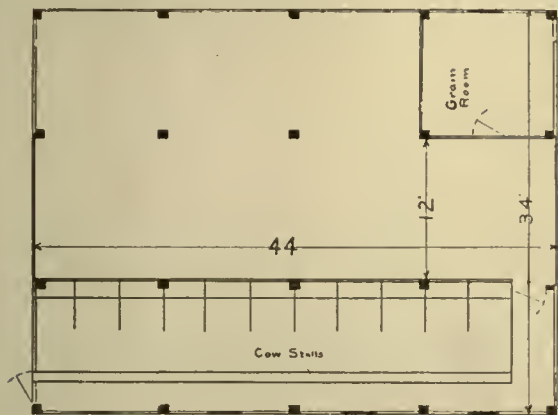

FIG. 32.—Ground plan.

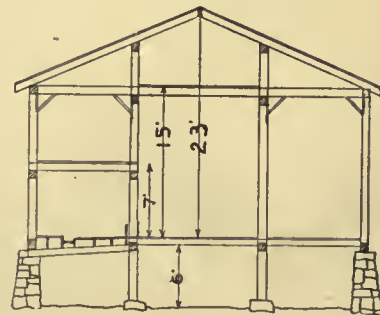

FIG. 33—Cross-section.

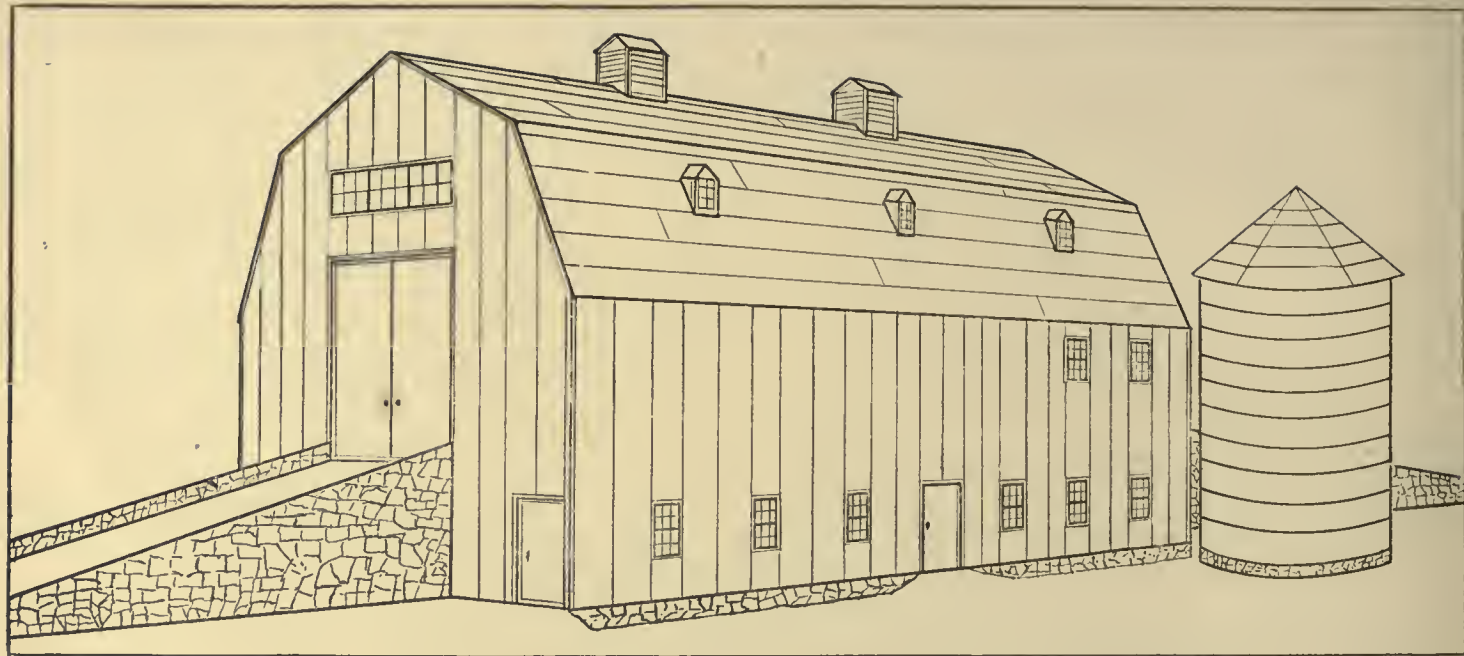

FIG. 34—A complete dairy barn, with silo.

A COMPLETE DAIRY BARN

Modern dairy farming means an up-to-date dairy barn, and we give herewith the plans of one which is warmly endorsed by the owner and carries fifty cows in perfect comfort. This is a truss-frame barn, ninety-three feet long by forty feet wide, the basement (or ground) floor being wholly occupied by cow stalls and calving pens, the main floor being a hay-storage room. Two bays on one side are used for grain storage, all the remainder of the bays on both sides being for hay; a driveway fifteen feet wide extends through this floor, and inclined driveways at each end give access from the fields in either direction.

The ground floor is concrete throughout. A walk five feet wide extends along each side and cross walks three feet wide are between each row of stalls at both front and rear, one for feeding and the other for the cows and the milkers. A shallow gutter, eighteen inches wide by six inches deep, extends along the rear of the stalls to receive the droppings and urine, which is removed twice a day and drawn at once to the fields or heaped for tramping over and rotting under wide-roofed sheds. The calving stalls, four at each end of this floor, are eight by seven and three quarters feet in size, and one or two of them can be occupied by bulls, if desired.

The watering system may be either a wooden gutter extending along the front of each row of stalls or a cast-iron semicircular pan set between each pair of stalls so as to supply a cow on either side. Whether troughs or pans are used there should be an automatic cock and tank, which keeps the water always at the desired level, and check valves which prevent the water once in the trough or basin returning to the pipe and contaminating others.

All the food is stored on the main floor, whence convenient chutes convey it to feeding troughs or push-carts on the walks below. The ensilage from the silo is loaded directly into the push-carts just outside the door, or could be chuted to the walk inside. The soiling crops fed in summer are cut up on the main floor and sent down to the waiting push-carts in the walks below. The roof and sides of this barn are covered with Paroid roofing.

The tying arrangement may be either chains, straps, or swing stanchions as desired, and all three methods are in use on up-to-date dairy barns. The stock kept may have an influence upon the length of the stalls; those given are seven and one half feet long by three feet three inches wide.

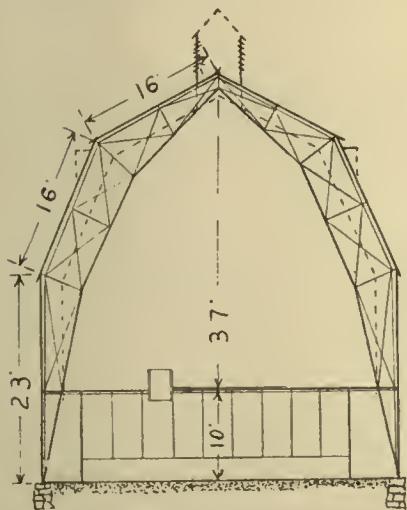

FIG. 35—Cross-section showing truss-frame plan.

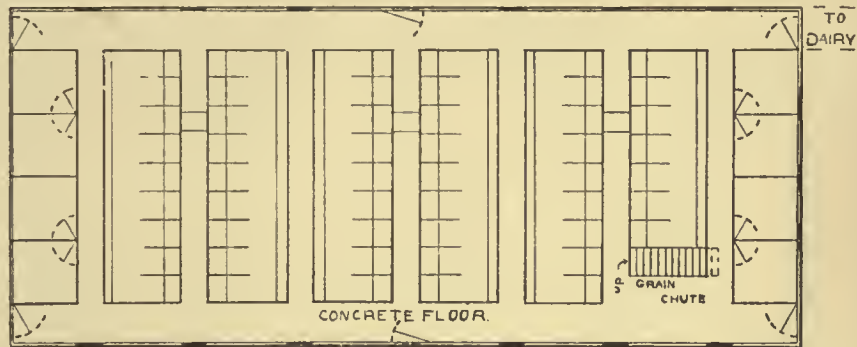

FIG. 36—Ground floor plan of basement story.

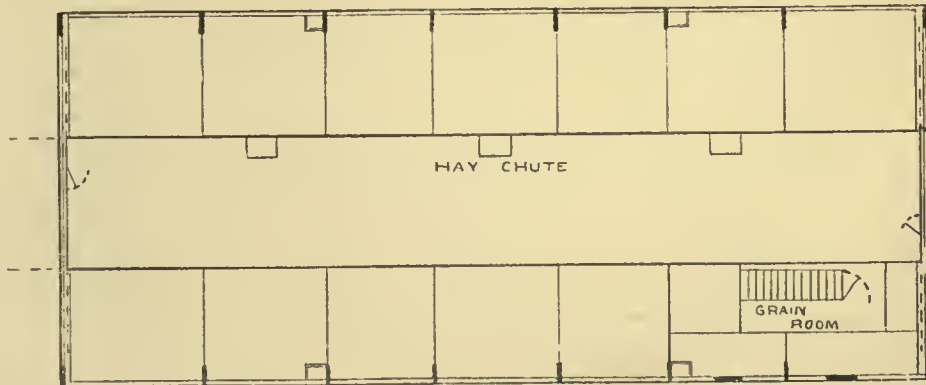

FIG. 37—Floor plan of main floor.

A STABLE FOR A SUBURBAN PLACE



FIG. 38—A stable for a suburban place.

horse room is such that no gases reach the carriages, and "Hydrex" waterproofing felt between the floorings of the carriage room cuts off the steam and gases from the manure pit. The iron gutter along the rear of the stalls is covered with a maple or birch plank, and the stall floors are either maple or birch. Running water is piped to the water basin in the horse room, and a hose cock on the other side of the partition receives the hose for washing carriages, or a revolving, overhead hose-fixture can be installed, just above the washing-floor if desired. A hot-water heater may be installed on the main floor, but better be in the basement, where the coal bin would be; radiators may be set as desired, with one at least in rear of the box stall and one on the carriage floor, and a small one in the man's room on second floor. The roof is drained by galvanized iron pipes emptying into blind wells. The carriage room floor is concreted, and a drain pipe leads from the depression where carriages are washed to a blind well. At one end is a platform for drying the bedding, and ventilation is so well provided for there are almost no odors. As it is planned this is a practical, convenient, well-arranged stable, adapted to the needs of a family of moderate means on a suburban place.

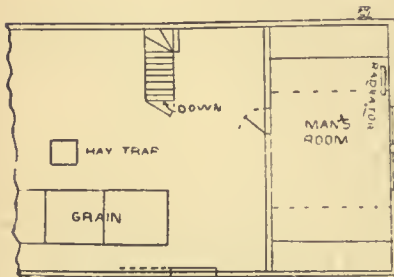

FIG. 40—Second story plan.

A convenient and well-arranged stable is greatly appreciated, and we present plans for a stable for four horses, with carriage room, harness room, man's room, etc., hayloft, platform for drying the bedding, and other accessories of a modern stable for a suburban home. It is built without cupola or other ornamental features, is just a plain, simple stable.

This building is forty-four by twenty-four feet in size, the sides and roof rough boards covered with Peroid Roofing. There is a basement under the whole.

The walls and ceiling of the entire lower floor are sheathed with hard pine, a wooden partition separating the horse stalls from the carriages, and abundant windows give light and air to all parts. The ventilation of the carriage room cuts off the steam and gases from the manure pit. The iron gutter along the rear of the stalls is covered with a maple or birch plank, and the stall floors are either maple or birch. Running water is piped to the water basin in the horse room, and a hose cock on the other side of the partition receives the hose for washing carriages, or a revolving, overhead hose-fixture can be installed, just above the washing-floor if desired. A hot-water heater may be installed on the main floor, but better be in the basement, where the coal bin would be; radiators may be set as desired, with one at least in rear of the box stall and one on the carriage floor, and a small one in the man's room on second floor. The roof is drained by galvanized iron pipes emptying into blind wells. The carriage room floor is concreted, and a drain pipe leads from the depression where carriages are washed to a blind well. At one end is a platform for drying the bedding, and ventilation is so well provided for there are almost no odors. As it is planned this is a practical, convenient, well-arranged stable, adapted to the needs of a family of moderate means on a suburban place.

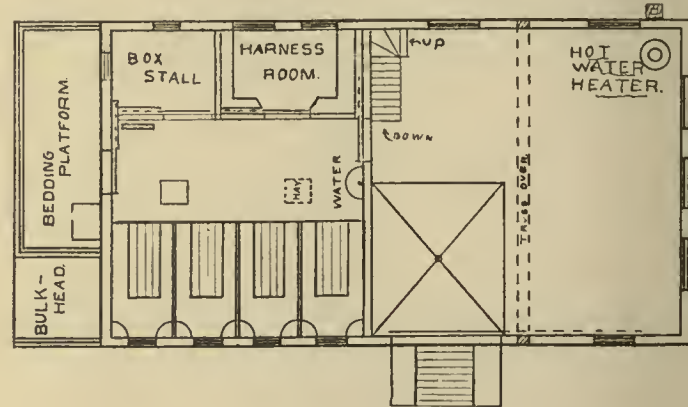

FIG. 39—Floor plan.

A PLANK-FRAME BARN.

The plank-frame barn has been very popular in several sections of the West, the considerable saving in lumber and ease of building recommending it to practical men. Less men and time are required to build one of these barns; they are stronger, the excellent "bracing" of the frame making them effective to stand the pressure of hay and grain within or strong winds without.

In some sections a solid frame foundation is used, in Maine the entire structure is of plank; the barns are built either with or without basement, according to the taste of the owner. A good, firmly built stone and cement foundation is advisable; with this foundation to rest the plank upon the frame is raised. Do not be sparing of spikes, they are an essential feature.

No sills are used, and the upright studs take the place of posts. Two for each post are set on the foundation on each side, between these is placed and spiked the cross-plank, which extends the width of the barn and ties the two sides together. The scantlings on each side of barn floor, forming center posts, are then raised and spiked in place. Upon

outside of each upright is spiked a plank of same size as, and parallel with, the first cross plank; this gives three 2x8's for cross sills through center of barn, each joint or band being fixed in this way. End joints, using boards instead of plank on outside, give the bedwork of the barn. At the sides, between uprights in place of sill, a plank is firmly spiked; this holds the uprights firmly in place and prevents working sideways, while the thoroughly spiked cross planks prevent all movement in other directions.

Some barns are boarded diagonally, some horizontally; both methods give excellent satisfaction. Many of these barns are built with a hip-roof, as in the illustration given, and these give a great amount of storage room in the loft. The steeper single-slope roof gives equally good results, looks well, and is a little more economical to build.

Paroid on roof and sides makes it wind and water-proof.

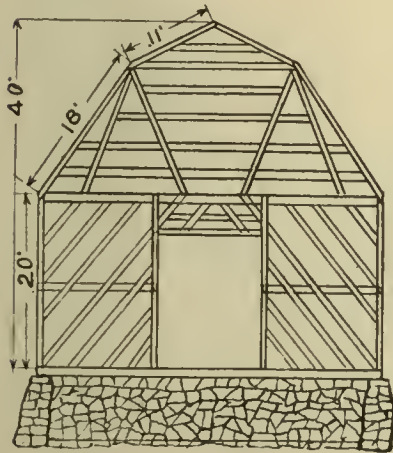

FIG. 43 Cross-section.

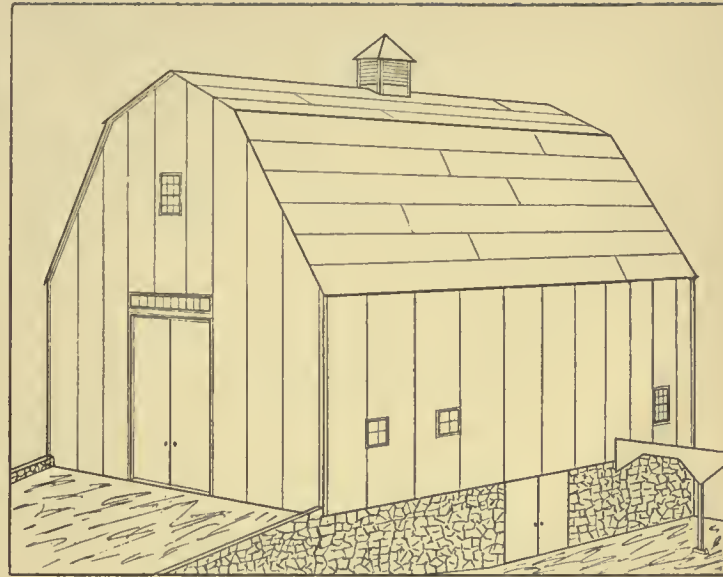

FIG. 41 A plank frame barn.

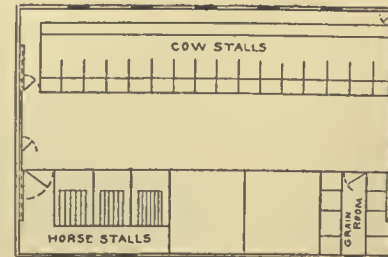

FIG. 42 Ground plan.

THE ECONOMY OF A GOOD ROOF

Nearly one hundred years ago we began making paper and felts, and for over twenty-five years have been making ready roofings. NEPONSET RED ROPE ROOFING was the first ready roofing ever made and it filled and is filling a long-felt want for a low cost roofing and siding. It was not intended for a permanent roofing, but has lasted in many instances over ten years. If it averages five to seven years, users say they get more than their money's worth.

About ten years ago we foresaw a large and growing demand for something more permanent. We had been making practical tests and experiments for years along this line and we placed PAROID Roofing on the market. It immediately became the standard ready roofing of the United States Government, the largest railroads, manufacturers, farmers and poultrymen all over the country, and it continues to hold their favor because it is a ready roofing of "quality."

The farmer uses a large part of our output for barns, silos, sheds, poultry buildings, and his dwelling house. It gives the same good results on all kinds of buildings.

We might go into detail and tell how we make PAROID, but we want to devote all the space we can to plans and specifications which will help you get up-to-date and economical buildings. Perhaps you have had some experience with tarred roofings, so we want you to know that PAROID and NEPONSET contain *no tar*.

Here are a few reasons for PAROID'S success. It is made of the most durable materials, which do not lose their vitality for many years. It is rain and cold proof, and this especially recommends it for poultry and farm buildings. A warm, dry building is very essential to successful farmers and poultry men. Of course no ready roofing is absolutely fireproof, but PAROID is proof against fire from sparks or embers, and buildings will never burn on account of PAROID being on the roof. It does not taint water, is of light slate color, and is acid, gas, and fume proof.

You don't need experienced men to apply PAROID. You or your own men can do it. We were the originators of the complete roofing kit, fixtures, and complete directions for laying packed inside of each roll. PAROID is so pliable that it can be easily laid in winter as well as in summer.

PAINTING

We don't advise painting PAROID for eighteen months to two years, and it is not necessary to do so then, but we recommend it because it is a better insurance for longer life and good service. The cost is very small and a coat every few years is a good investment.

SIDING

You cannot imagine the neat effect PAROID gives when applied to the sides of a building with cleats or battens. You can, without extra expense, make your buildings look neat, at the same time make them warm and dry by using PAROID on roof and sides.

NEPONSET RED ROPE ROOFING

Has more good qualities than any other roofing made for the money. It has stood the test of time, and those who first used it are still using it, which is proof enough of the good work NEPONSET will do. It is waterproof and windproof, does not taint rain water, and is easily applied. Each roll contains fixtures and complete directions for applying.

A GOOD COMBINATION

The farmer's and poultryman's most economical combination is PAROID for the roof and NEPONSET applied with battens, for the sides, unless, of course, you feel you can afford PAROID for sides also.

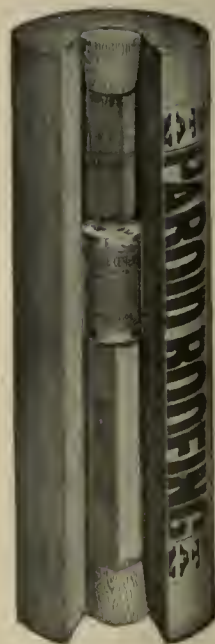

Tin caps, nails, cement, and complete directions for laying are packed in each roll.



Brooder house, roof covered with PAROID, White Leghorn Poultry Yards, Waterville, N. Y.

especially for our roofings, and are sure to stick, whereas lead and oil, not having any affinity for the PAROID coating, are liable to peel off.

SIZE OF ROLLS

PAROID is put up in rolls thirty-six inches wide, which contain two squares and enough extra for a two-inch lap. (A square is ten by ten feet.) NEPONSET is put up in rolls thirty-six inches wide, which contain one hundred, two hundred and fifty and five hundred square feet.

Fixtures and complete directions for applying are packed inside of each roll of PAROID and NEPONSET.

Send us the dimensions of your buildings and we will tell you what enough PAROID and NEPONSET to cover will cost, delivered to your nearest railroad station.

We realize that you may be considering some other roofing material which is perhaps cheaper than PAROID, and that the temptation to buy this imitation will be great. We also realize that the imitation may look like and appear to be equal to PAROID, but do not be deceived by the appearance. We claim emphatically



PAROID covers a Vermont farm barn.



Duck breeding house, roof and sides covered with PAROID, Weber Bros., Pondville Mass.

LINING PAPERS

Some people prefer to use a sheathing paper for lining their poultry houses or other buildings, and others use it under roofing and siding. Of course it makes a tighter and warmer building, but it is not absolutely necessary. NEPONSET BLACK WATERPROOF PAPER is an inexpensive paper when one wishes a lining paper.

PAINTS

Because ordinary paints do not wear well on PAROID and NEPONSET, we make PARINE (black) and NEPONSET (dark brown) PAINTS. These do not cost as much as the ordinary lead and oil paints. Our paints are made



Colony chicken houses on farm of G. M. Gowell, of the Maine Agricultural Experiment Station, Orono, Maine. The roofs are covered with PAROID, sides with NEPONSET.

that the imitations of PAROID grow brittle with age, are liable to buckle on the roof, are hard to apply, and in a short time are unsightly in appearance, all of which make a dissatisfied customer. The manufacturers themselves do not know how long they will last, for most of them have been on the market only a year or two.

PAROID may cost a little more than these imitations, but the difference in cost is not the difference in the profit which we make, but is the difference in the quality of the material. You cannot afford to use a cheap roofing at any price.

The most recent endorsement given by the United States Government was the choosing of PAROID for work on the Panama Canal. The specifications for this work called for "PAROID or equal," and while nearly a hundred bids were received on imitations of PAROID, the whole order was placed with us. The Government has used many million square feet of PAROID in this country, Cuba, and the Philippines.

If you will look up the records of PAROID and the imitations before you place your order, and choose the one with the best record, we will both be satisfied.

We have only told you some of the things you ought to know about roofings and have devoted the rest of the space to up-to-date economical farm buildings and specifications, which we trust will be helpful when you build. Please remember that we are here to help you with your building troubles in any way that we can. Don't fail to write us.

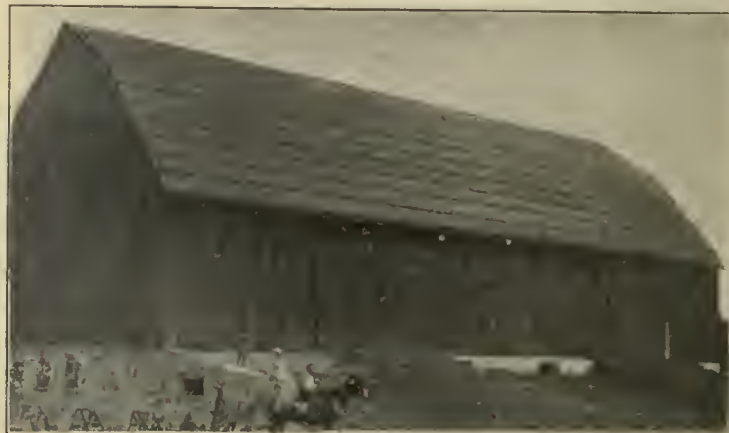

PAROID on a Canadian farm barn.



Meadow Brook Farm poultry plant, Dallas, Pa. Roofs are covered with PAROID.

KENDALL MILLS, N. Y.

F. W. BIRD & SON.

Dear Sirs:—Please send me your agent's address at Rochester. We want to use some of your Neponset Red Rope Building Paper. We have some and think nothing can heat it.

Yours and oblige,

FRED WINTER.

CENTER SANDWICH, N. H.

Gentlemen:—I am very much obliged to you for your booklet. I am perfectly delighted with Paroid Roofing. Have used it on my chicken and squah houses. I bought of Mr. Brown of Ashland, N. H., who handles your goods. I expect to send you a large order soon. Will do my utmost for you in this section.

Respectfully,

FRED WILLIAMS, SR.

EAST NORTHFIELD, MASS.

F. W. BIRD & SON, EAST WALPOLE, MASS.

Dear Sirs:—Your communication of the 18th at hand. Sample of Paroid arrived in due time, and I am much pleased with it and shall give it a trial. I shall want some at our farm in Montville, Conn., in the Spring. I have used your Neponset for the past ten years and like it very much.

Yours very truly,

J. R. COLTON.

EAST LYME, CONN.

Gentlemen:—Enclosed please find P. O. order for \$5.00. Please send me by freight five hundred feet Neponset Red Rope Roofing. You furnished us in 1891 for our brooder house covering quite a large amount of this paper. I inclose a small sample of it. It is as good as the day it was put on. H. F. Cutter & Co. was the firm you sent it to. I consider it the best roofing of the kind I have ever seen.

Yours very truly,

WM. T. CUTTER.



Barn on the largest stock farm in Minnesota. Eight hundred squares of PAROID put on roof of this barn by the farm hands themselves.

F. W. BIRD & SON, EAST WALPOLE, MASS.

Gentlemen:—We have just paid a visit to our farm at Relay, Md., and are greatly pleased to find the Paroid Roofs of our dairy barns and poultry buildings in such a fine state of preservation. If you will remember, it is some five years since we put the first roof of Paroid on one of the big poultry houses, as an experiment, and it stood so well, even though we had never used a drop of paint on it, that we forgot it was there. Two years later our big barns were destroyed by fire, and with the barns went all the buildings but this one poultry house, which was undoubtedly saved by its Paroid Roof. So impressed were we with this fact that on rebuilding, we covered the big new dairy barns, 242 feet in length, with 2-ply Paroid. A year ago, on the 28th of January, our house was burned to the ground and all the buildings were again subjected to a baptism of sparks from the burning building, but thanks to Paroid, none of the outbuildings were burned. No leaks have occurred during the year past and the roofs seem to be in perfect condition.

Faithfully yours,

CLEMENT & CLEMENT.

BURLINGTON, VT.

MESSRS. HAGAR BROTHERS, BURLINGTON, VT.

Dear Sirs:—I think it was three years ago this spring that the horse barn at our farm on North Avenue, this city, was covered with Paroid Roofing bought of you. It has never leaked a drop, presents a good appearance, and, apparently, it is as good as when first put on. I am satisfied.

Respectfully,

A. B. KINGSLAND.



PAROID covers the Plant Industry Buildings, U. S. Department of Agriculture, Washington, D. C



A hog house on a Vermont farm, covered with PAROID.



Duck plant of James Rankin, South Easton, Mass. West side of lane, showing 250-foot brooding house 125-foot breeding house and 100-foot barn. The roofs are covered with PAROID.

MARBLE HILL, GA.

MESSRS. J. M. ALEXANDER & CO., ATLANTA, GA.

Gentlemen:—We are pleased to be able to testify that the Paroid Roofing (sixty-three squares) bought from you in June, 1901, has given us entire satisfaction. We have not spent a penny for repairs since putting it on. We were so well pleased with it that we ordered ninety squares more in September, 1902, to cover the extension to our new mill.

We believe it to be the best and most economical roofing that can be used.

Yours truly,

THE SOUTHERN MARBLE CO.

WALBROOK, BALTIMORE, MD.

MESSRS. F. W. BIRD & SON, EAST WALPOLE, MASS.

Gentlemen:—The Paroid Roofing bought of you last fall for cow stable roof on one of my farms has given great satisfaction—in fact it is far superior to steel, that cost me just four times the price. For those wishing your roofing in my section, you can refer to me for reference. I thought you should know this. With regards,

Yours truly,

FRANCIS SANDERSON.

PICTURE ROCKS, PA.

F. W. BIRD & SON, EAST WALPOLE, MASS.

Gentlemen:—I received sample of Paroid Roofing, also Red Rope Roofing. I have used fifteen squares of your Red Rope Roofing in the last eleven years. I have some in use as siding that has been on ten years, and is good for that many more. Your Paroid is all right, and I shall need some next fall. Do you make candy boxes of one quarter and one half pound size, like draft? If so, send me samples and prices.

Yours truly,

WILLIAM H. STEELE.

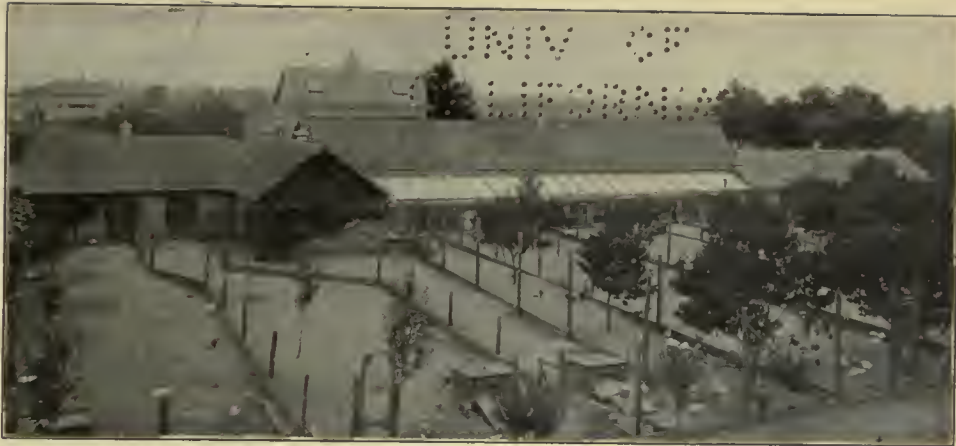

Monmouth Poultry Farm, Freneau, N. J. Roof covered with PAROID.



PAROID on cattle shed on Beechfield farm
Arlington, Baltimore Co., Md.



PAROID covers a Vermont barn and silo



A cow barn, East Greenwich, R. I. Roof covered with PAROID.

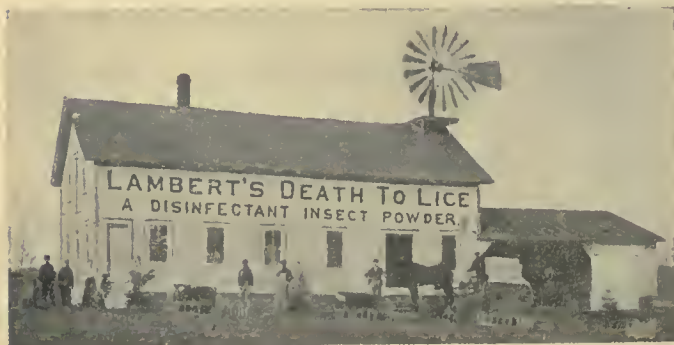

D. J. Lambert says: "PAROID is all right;" and he knows.



PAROID covers a farm barn, Burlington, Vt.

YC 65649

GENERAL LIBRARY - U.C. BERKELEY

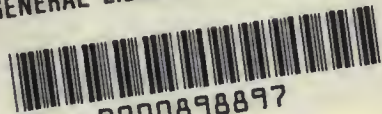

8000898897

272127

S581

H8

UNIVERSITY OF CALIFORNIA LIBRARY

